



HD Conference Camera

User Manual

BG-CAM-10XA

BG-CAM-20XA

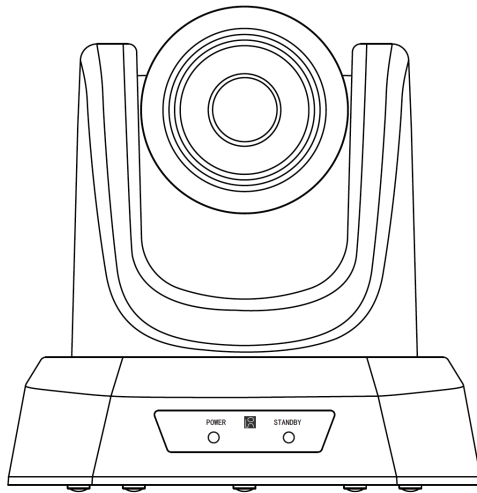

Contents

Product Description

Foreword	-----	1
Notice	-----	1
Supplied Accessories	-----	1

Performance Characteristics

Tech parameters	-----	2
Camera parameters	-----	2

Quick Start

Interface definition	-----	3
Interface diagram	-----	4
Installation instructions	-----	4

Remote Control Button Description

Remote control instructions	-----	5
-----------------------------	-------	---

Common Operation Instructions

Common operation instructions	-----	7
-------------------------------	-------	---

Camera Menu Set

Camera Menu Setup	-----	9
-------------------	-------	---

Trouble Shooting

Troubleshooting	-----	14
-----------------	-------	----

Warranty

Warranty	-----	15
----------	-------	----

Attention

1. Foreword

Thanks for choosing our conference cameras. Please read this manual carefully before using the product.

2. Notice

- Avoid damage from vibration and moisture during storage and installation.
- Handle the camera parts. Please do not touch the camera lens by hand to avoid scratching the lens.
- Use only the specified voltage. Using improper voltage increases the risk of an electric shock or fire.
- Do not aim the camera at the sun or the other high luminous objects. It may cause image blurring or lens flare and can cause permanent damage to the camera.
- Do not clean camera with active chemical or corrosive detergents, and remove dust or dirt on the components with compressed air.
- Do not disassemble any camera components. In case of abnormal operation contact your authorized dealer or the store where you purchased the product.

3. Supplied Accessories

- (1) HD conference camera
- (2) DC12V-2A power supply
- (3) Manual
- (4) Remote control
- (5) USB cable

Performance Characteristics

1. Camera technical parameters

Electric		Communication	
Input Voltage	DC12V	Baud	9600/38400bps
Power	12W	Protocol	VISCA/PELCO-D/PELCO-P
Decoder	internal	Address Set	0~64
Operation		Surroundings	
Horizontal Rotation	±175°	Operating Environment	0°~+50°
Vertical Rotation	120°	Operating Temp	0~95%
Rotation Speed	100°/s		non-condensing
Physics		Installation Method	
Preset Point	Preset Point: 9 for remote control, 256 for PELCO, 64 for VISCA	Support desktop, wall mount, ceiling mount and tripod installation	
Net-Weight	1.46kg		

2. Camera Parameters

Spec \ lens	10x optical zoom	20x optical zoom
Image Sensor	1/2.9" SONY HD CMOS	1/3" SONY HD CMOS
Effective Pixel	2.1 Mega Pixel	2.1 Mega Pixel
FOV	51.3°~4.64°	55.5°~3.0°
Focal Length	f=5.0-50.0mm	f=5.35-107.0mm
HD Format	1080P (1920*1080) 720P (1280*720)	
HD Interface	USB,HDMI,SDI	
Resolution	1080P/720P	
Signal System	NTSC/PAL	
Control parameters		
Preset	Preset Point: 9 for remote control, 256 for PELCO, 64 for VISCA.	
Translation/ Pitching Angle	-175°~175° -35°~55°	
Translation/ Pitching Speed	100°/s 80°/s	
Control Protocol	VISCA,PELCO-D,PELCO-P	
Control Interface	RS-232, RS485	
Common Parameters		
Size	Product : 162*172*175mm	

Quick Start

1. Interface definition

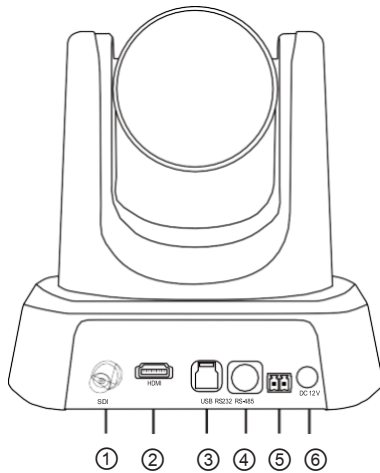
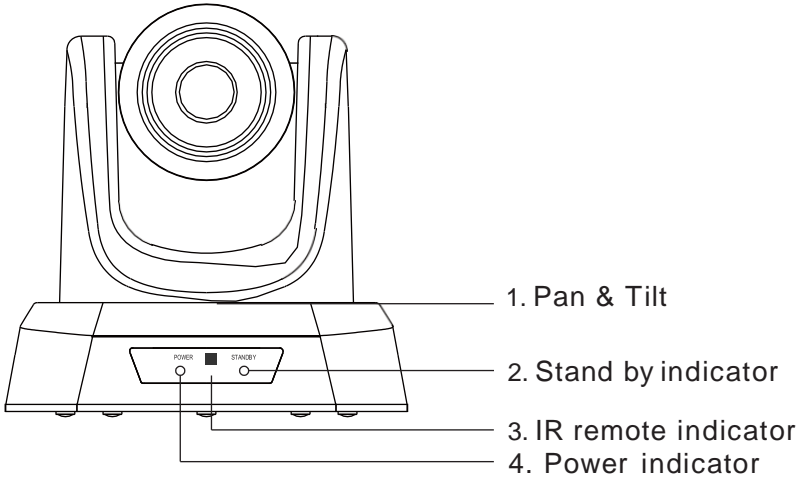

- | | |
|------------|------------|
| (1) SDI | (2) HDMI |
| (3) USB | (4) RS232 |
| (5) RS-485 | (6) DC 12V |

2. Interface diagram

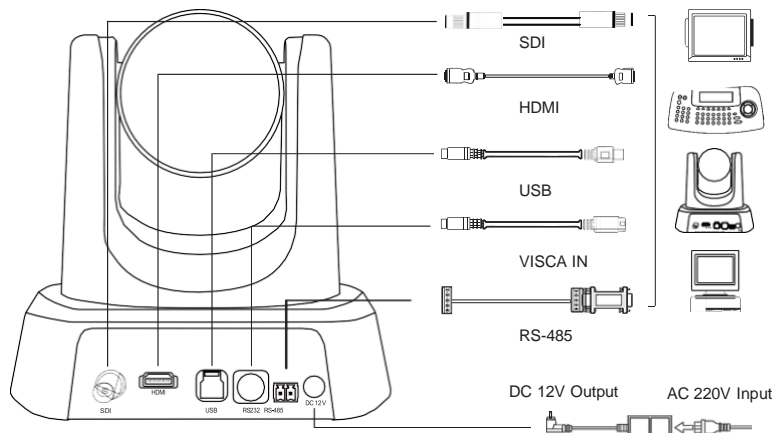

3. Installation instructions

(1) Surface Installation

Put the camera on the desk flatly, and make sure the camera is in level. If you want to put the camera on an oblique surface, please make sure the angle of inclination is less than 15 degrees to ensure the camera pan and tilt working in normal operation.



(2) Ceiling Mount Installation

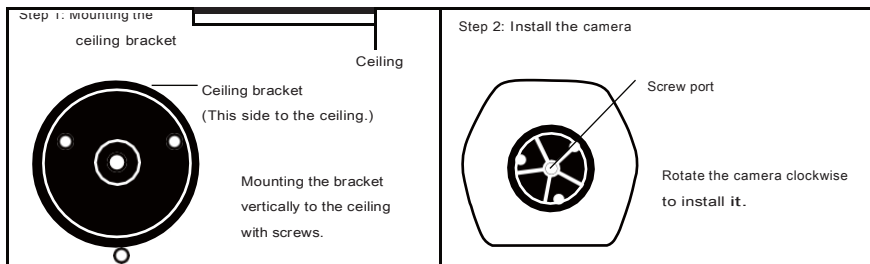

Remote Control Button Description

- (1) Remote Control Launch Window
- (2) 【POWER】 Standby Button, pressing it, camera goes into Standby Mode; pressing again, camera goes Power ON.
- (3) 【P/T Reset】 Camera Pan/Tilt reset Function same with ⑧ (P/T RESET)
- (4) 【CAMERA SELECT】 Choose the camera number that needed to control, to correspond the dial-up code on the back of camera;
- (5) 【POSITION】 Preset position setup keys, include 【PRESET】 and 【RESET】 .
- (6) 【UP】 :camera rotating horizontally in regular installed direction
- (7) 【DOWN】 :camera rotating horizontally in reversed installed direction
- (8) 【PAN-TILT】 【PAT-TILT】 camera rotation control key: press this button and move by the arrow direction, press Press 【HOME】 to back to the center of vertical and horizontal position.

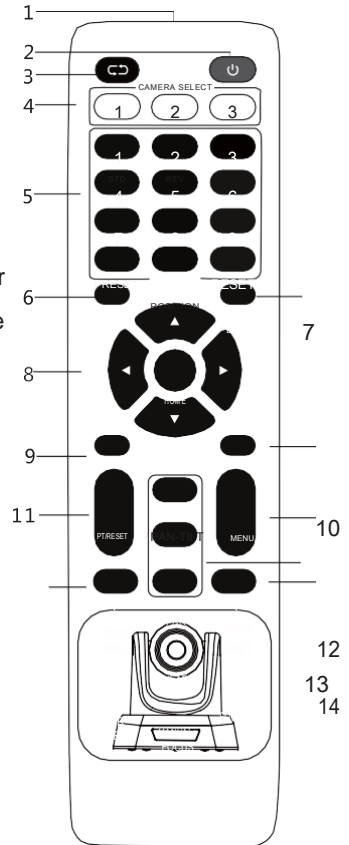

(9) **【 Camera Pan/Tilt Reset 】** : Camera Pan/Tilt reset ;

(10) MENU.

(11) Slow Zoom Key

【Zoom SLOW+】 T : Zoom in at low speed

【ZOOM SLOW-】 W : Zoom out at low speed

(12) Fast Zoom Key

【ZOOM FAST +】 : Zoom in at fast speed

【ZOOM FAST -】 : Zoom out at fast speed

(13) Manual Focus Mode

【MANUAL FOCUS】 : Start manual focus function

【FAR】 : Manually far focus button, clearer for the distant objects, loose finger to stop.

【NEAR】 : Manually near focus button, clearer for the nearby objects, loose finger to stop.

(14) **【AUTO FOCUS】** : Auto Focusing Button

ATTENTION

1. If there is an object between remote control and camera sensor, the camera will not respond. Please make sure the remote control is aimed directly at the sensor during operation.
2. L/R SET and Menu keys are not applicable for this model.
3. Fast zoom key, slow zoom key, manual and auto focus keys not applicable for fixed focus model.





Common Operations Introductions

1. Camera Select



Refer to the dial-up at the back of camera and choose camera address number that you want to control (1-3)

2. Camera Direction Control

-  Turning up
-  Turning down
-  Turning to left
-  Turning to right

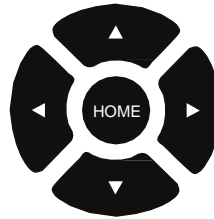

*Note: Press direction key to move the camera. Press the direction key when you need to change the angle. If you want to move the camera slowly, just click the direction key; If you want to move the camera fast at a large scale, just long-press the button.

3. Camera Focusing Mode Control

【AUTO】 Switch the focus mode to AUTO

【MANUAL】 Switch the focus mode to MANUAL

【FAR】 Far focus manually

【NEAR】 Near focus manually

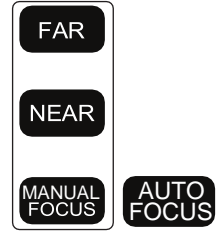

4. Camera Zoom Control

Press any one of the 4 **【 ZOOM 】**

to make the zoom functioning.

These 4 keys are not applicable for fixed focus camera.



5. Preset Setup, Call, Cancel

(1) Reserve Preset: Press **【PRESET】** then press one of the number (1-9) to reserve a preset that correspond to the NUMBER.

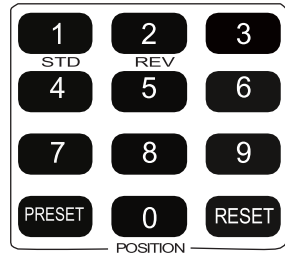

*Note: you can setup 9 presets at most by the remote control.

(2) Call Preset: Press the NUMBER (1-9) directly to call the reserved preset.

*Note: It won't work if there's no preset reserved in the corresponded number.

(3) Remove Preset: Press **【RESET】** , then press one of the numbers (1-9) to remove a preset that correspond to the NUMBER.

Camera Menu Setup

Menu Description

Operate remote control, press 【 MENU 】 to enter main menu of video camera;

Level I Menu - MAIN MENU :

Main Menu	
Image	->
Display	->
Lens	->
System	->

Level II Menu - Image:

Image	
Exposure	
Wb	
ImageE.n	
HDMI Output	1080P50
Mirror	Off

HDMI output: Support 1080P60/50/30/25, 720P60/50, 1080i 60/50.
Mirror: Support Off /Left/Right/Up/Down image adjust.

Level III Menu -Exposure

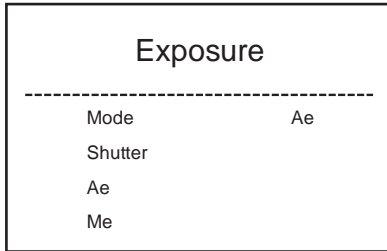

Exposure Mode: Support Auto/Manual mode.

Shutter priority: adjust the shooting speed.

Level III Menu -WB

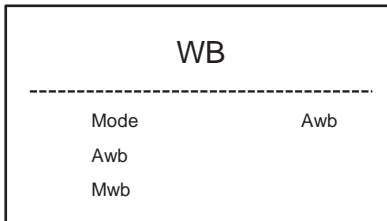

WB Mode : Support Auto / Manual mode.

Level III Menu -Image Enhancement

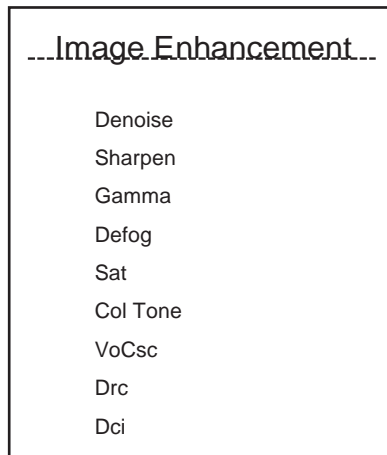

Denoise: 2D noise reduction /3D noise reduction switch

Sharpen: Sharpness adjustment function

Gamma: Gamma adjust switch

Defog: Defogging: the defogging strength is calculated automatically according to the manual/automatic specified strength coefficient.

Sat: Adjust the image color effect.

Col Tone: Color tone adjustment interface. The video output result is independent of the color temperature.

VoCsc: VD outputs brightness values, hue values, saturation values, and contrast values.

Drc: Dynamic range adjustment

Dci: Adjust image contrast and brightness dynamically

Level II Menu - Display

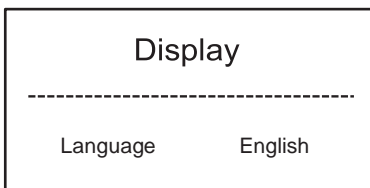

Language: Support Chinese/English

Level II Menu - Lens

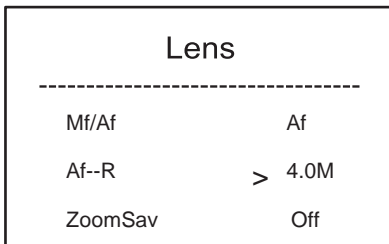

Focus mode: Support auto and manual 2 modes

Range of focus: Determined by the lens used in the model.

Zoom save: When the camera is turned on, restarting the camera will initialize to the position which was shut down in last time.

Level II Menu – System

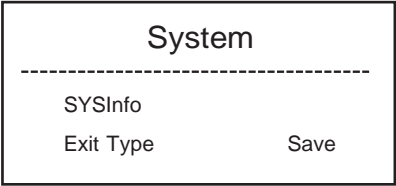

System info: Firmware version and time

Exit Type: Save / Not save / Default

(Select here to determine to save all parameters been adjusted or not.)

Level III Menu -System info

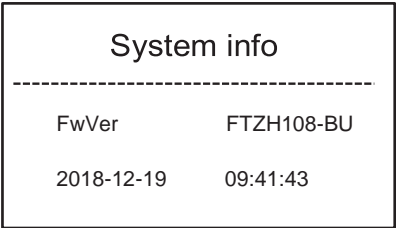

Dial-up:

1. Dial-up ON/OFF set

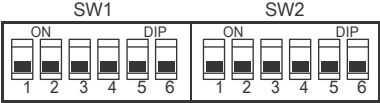

2. Dial-up SW1(1,2,3,4,5,6): Baud rate set

SW1						
PTZ Add.	DIP-1	DIP-2	DIP-3	DIP-4	DIP-5	DIP-6
1	ON	OFF	OFF	OFF	OFF	OFF
2	OFF	ON	OFF	OFF	OFF	OFF
....						
64	ON	ON	ON	ON	ON	ON

3. Dial-up SW2(1/2/3): Protocol set

SW2				
Protocol	DIP-1	DIP-2	Baud	DIP-3
VISCA	OFF	OFF	9600	OFF
PELCO-D	OFF	ON	38400	ON
PELCO-P	ON	OFF		

4. Dial-up 3 IR transfer (IR PASS), DIP-4 reserve

IR Add.	DIP-5	DIP-6	DIP-4
All	OFF	OFF	RESERVE
1	OFF	ON	
2	ON	OFF	
3	ON	ON	

PS: RS-485 and RS232 Pins distribution

1、 Control Interface

(1) RS485 Interface Distribution

PIN NUM	FUNCTION
A	DTR IN+(connect to RS-485)
B	DSR IN+(connect to RS-485)

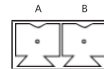

(2) RS-232 Interface Distribution

VISCA RS-232C IN

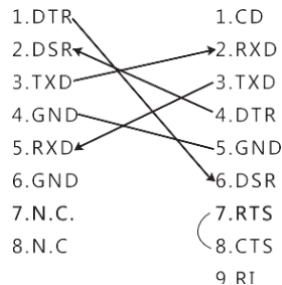

Troubleshooting

-The video of camera cannot be displayed on the screen

- Check the power, data, and video connections

-Camera does not Pan, Tilt or zoom.

- Menu was displayed on monitor – exit menu and retry

-Image quality is poor while using in low-light conditions

- Press 【BACK LIGHT】 on remote control or menu (ON/OFF) to adjust backlight effect

-Remote control works intermittently or not at all

- Check batteries

- Choose the correct “IR select” number to match camera

- Ensure remote is within 15m of camera

- Ensure there are no obstructions between remote control and camera sensor

- Aim at the sensor on the front of the camera

-USB interface is not identifiable

- Check USB cable and extension cable are securely connected

- Connect to another USB interface and try again.

-No image after HDMI interface connects

- Check the HDMI cable

- Verify the video format is compatible with display device

- Recommended cable length 30m or less

-Control via RS232/RS485 is not responding

- Make sure camera and PC are properly connected. (Reference to RS-422/485 and RS232 Pins distribution in page 16.)

-Can camera be mounted to the wall?

- Yes. Camera comes with ceiling mount, wall mount or tripod brackets sold separately.

Warranty

BZBGEAR wants to assure you peace of mind. All BZBGEAR cameras and camera-related products include our Stress-Free Three-Year Warranty.

For complete warranty information, please visit BZBGEAR.com/warranty.

For questions, please call 1.888.499.9906 or email support@bzbgear.com.

Mission Statement

BZBGEAR manifests from the competitive nature of the audiovisual industry to innovate while keeping the customer in mind. AV solutions can cost a pretty penny, and new technology only adds to it. We believe everyone deserves to see, hear, and feel the advancements made in today's AV world without having to break the bank. BZBGEAR is the solution for small to medium-sized applications requiring the latest professional products in AV.

We live in a DIY era where resources are abundant on the internet. With that in mind, our team offers system design consultation and expert tech support seven days a week for the products in our BZBGEAR catalog. You'll notice comparably lower prices with BZBGEAR solutions, but the quality of the products is on par with the top brands in the industry. The unparalleled support from our team is our way of showing we care for every one of our customers. Whether you're an integrator, home theater enthusiast, or a do-it-yourselfer, BZBGEAR offers the solutions to allow you to focus on your project and not your budget.

All the contents in this manual and its copyright are owned by BZBGEAR. No one is permitted to imitate, copy, or translate this manual without BZBGEAR's permission. This manual contains no guarantee, standpoint expression or other implies in any form. Product specification and information in this manual is for reference only and subject to change without notice.

All rights reserved. No reproducing is allowed without acknowledgement.